



DesignLights Consortium™ Qualified Luminaires:
 ST35QA1X279(U)HJ5KC***
 ST35QB1X279(U)HJ5KC***
 ST35QC1X279(U)HJ5KC***
 ST35QD1X279(U)HJ5KC***
 ST35QF1X279(U)HJ5KC***



S35

Housing:

Heavy-Duty Low Profile Die Cast Housing with Integral Heat Sinking, Driver Compartment. Powdercoat Finish Over a Chromate Conversion Coating. Includes Twist Lock Photocell Receptacle.

Listing & Ratings:

CSA: Listed for Wet Locations, ANSI/UL 1598, 8750 IP66 Sealed LED Compartment.

Lens:

Tempered Clear Flat Glass Lens or Tempered Clear Flat Prismatic Glass Lens

Mounting:

2 3/8" Diameter Mounting Arm, Adjustable Slipfitter, or Two-Piece Swivel Bracket.

LumaFit LED:

Delivered Lumens: 26,000 to 35,500
 CRI: 86; CCT: 4000K, 5000K
 Rated Life: 50,000 Hours; Aluminum Boards

Wattage:

Array: 278.8w, System: 301.3w

Driver:

Electronic Driver, 120-277V, 50/60Hz or 347-480V, 50/60Hz; Less Than 20% THD and PF>0.90. Standard Internal Surge Protection 6kV. 0-10V Dimming Standard for a Dimming Range of 100% to 10%; Dimming Source Current is 150 Microamps.

Controls:

Fixtures Ordered with Factory-Installed Photocell or Motion Sensor Controls are Internally Wired for Switching and/or 1-10V Dimming Within the Housing. Remote Direct Wired Interface of 1-10V Dimming is Not Implied and May Not Be Available, Please Consult Factory. Fixtures are Tested with LEPA Controls and May Not Function Properly With Controls Supplied By Others. Fixtures are NOT Designed for Use with Line Voltage Dimmers.

Warranty:

5-Year Warranty for -40°C to +50°C Environment.

Options:

Surge Protection

Custom Colors Available Upon Request.

Bentley Large Area/Roadway		
Catalog #	Description	
Complete Units		
Ordering Information		
Example: S35F279U5KCZMASP		
S35	Model:	S35
F	Optics:	A=Type I, B=Type II, C=Type III, D=Type IV, F=Type V
279	Wattage:	279
U	Ballast:	U=120-277V, H=347-480V
5K	CCT:	4K=4000K, 5K=5000K
C	Lens:	C=Tempered Clear Flat Glass Lens, P=Tempered Clear Flat Prismatic Glass Lens* *Use with F Optic Only.
Z	Color:	Z=Bronze
MA	Mounting:	BR=Two-Piece Swivel Bracket, SF=Slipfitter, MA=Mounting Arm Adapter
SP	Options:	R3=3-Pin Twist Lock Photocell Receptacle, R5=5-Pin Twist Lock Photocell Receptacle, R7=7-Pin ANSI C136.41-2013 Twist Lock Receptacle, SF=Single Fuse, DF=Double Fuse, SP=Surge Protection P40=P18140 110-120VAC Instant, P42=P18142 105-287VAC Instant, P50=P18150 120VAC Time Delay, P52=P18152 277VAC Time Delay, P56=120-277VAC Universal

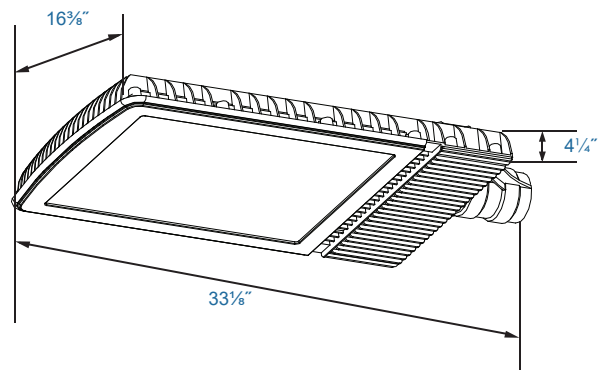

S35

Catalog #	Description
ST35GLP	Tempered Clear Flat Prismatic Glass Lens
ST35GSZ	Aluminum House Side Shield, Bronze Powdercoat Finish, Includes Hardware.
ST35WG	Wire Guard, Stainless Steel Construction
STSFZ	Adjustable Die Cast Double Slipfitter with Angle Indicators Allows Mounting on Vertical Tenons, Includes Hardware. Bronze Finish.
CVMAZ	Die-Cast Adaptor for 2 3/8" Horizontal Mounting Arms, Bronze Powdercoat Finish, Includes Hardware.
FL90BRZ	Two-Piece Stamped Steel Adjustable Bracket, Bronze Powdercoat Finish, Includes Hardware.
FL90SFZX	External Mount Die-Cast Adjustable Slipfitter for 2 3/8" Tenons, Bronze Powdercoat Finish, Includes Hardware.
PSS4T180HTZ	4" 180° Twin Square Horizontal Tenon, Bronze Finish
PSS5T180HTZ	5" 180° Twin Square Horizontal Tenon, Bronze Finish
PTSB1SZ	Single Pole Tenon Spoke Bracket, 2 3/8" Horizontal Mounting Arm, Bronze Powdercoat Finish, Includes Hardware.
PTSB290SZ	Twin Pole Tenon Spoke Bracket, 2 3/8" Horizontal 90° Mounting Arms, Bronze Powdercoat Finish, Includes Hardware.
PTSB2180SZ	Twin Pole Tenon Spoke Bracket, 2 3/8" Horizontal 180° Mounting Arms, Bronze Powdercoat Finish, Includes Hardware.
PTSB390SZ*	Triple Pole Tenon Spoke Bracket, 2 3/8" Horizontal 90° Mounting Arms, Bronze Powdercoat Finish, Includes Hardware.
PTSB3120SZ*	Triple Pole Tenon Spoke Bracket, 2 3/8" Horizontal 120° Mounting Arms, Bronze Powdercoat Finish, Includes Hardware
PTSB490SZ*	Quad Pole Tenon Spoke Bracket, 2 3/8" Horizontal 90° Mounting Arms, Bronze Powdercoat Finish, Includes Hardware.
P18130	480VAC Twist Lock Photocell Receptacle
P18130R5	5-Pin Twist Lock Photocell Receptacle ANSI C136.41-2013 with Integrated Controls for LED, 480 VAC
P18130R7	7-Pin Twist Lock Photocell Receptacle ANSI C136.41-2013 with Integrated Controls for LED, 480 VAC
P18131	Twist Lock Non-Shorting (Open) Cap Disconnects Service to Fixture for Temporary or Permanent Disabling (Fixture Always Off). IP65, 480V Maximum.
P18132	Twist Lock Shorting Cap Provides Fixed Service to Fixture (Fixture Always on). IP65, Rated Load 7200w Tungsten.
P18140	110-120VAC Instant Twist Lock
P18142	105-287VAC Instant Twist Lock
P18150	120VAC Time Delay Twist Lock
P18152	277VAC Time Delay Twist Lock
P18154	480VAC Time Delay Twist Lock Photocell. For 480V use only.
P18156	120-277VAC Universal Twist Lock Photocell

*Non-stock item. Consult factory for lead time.

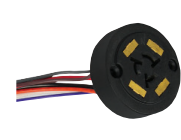
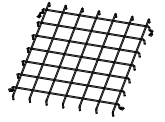
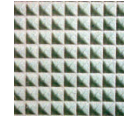
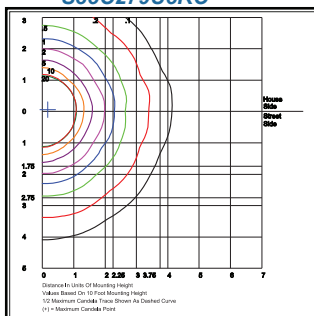
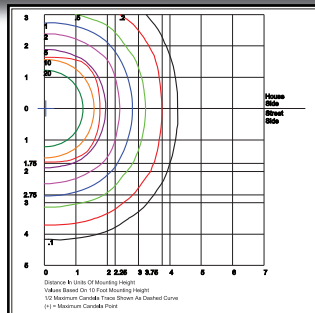
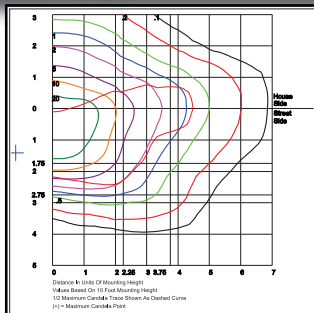

*Shown Mounted